



Emergent
Gravity

www.emergentgravity.org



Experimental verification of the **stimulated** Hawking process



by

- ⊞ **Greg Lawrence**
- ⊞ **Matt Penrice**
- ⊞ **Ted Tedford**
- ⊞ **Mauricio Richartz**
- ⊞ **Bill Unruh**
- ⊞ **Silke Weinfurtner**

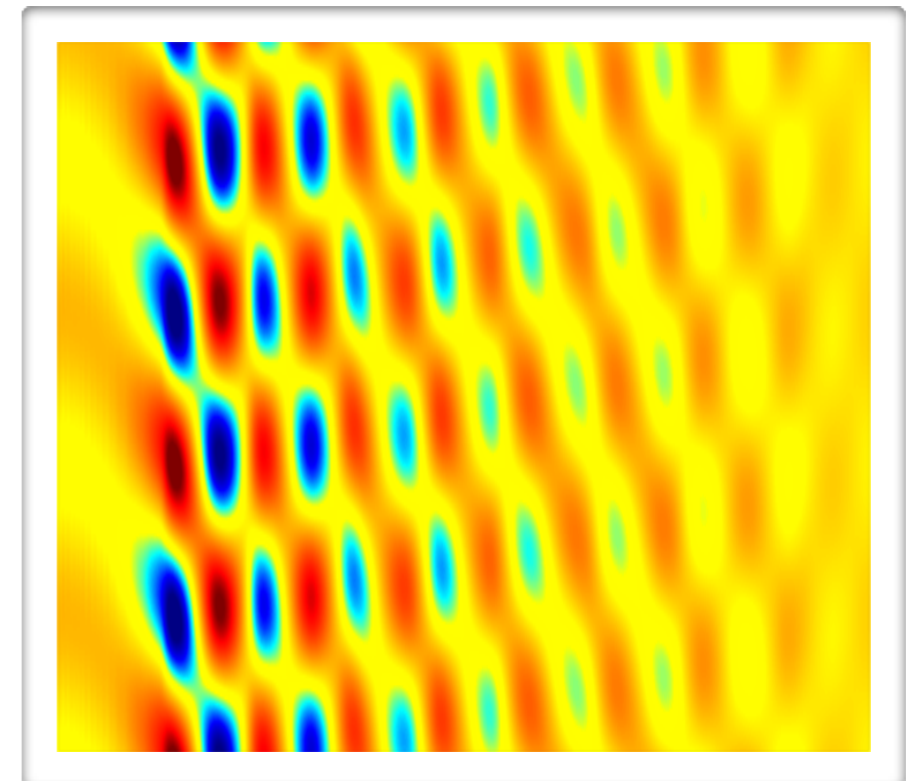

Motivation - The importance of Hawking radiation..?

[Images taken from 'The road to Reality', by Roger Penrose.]

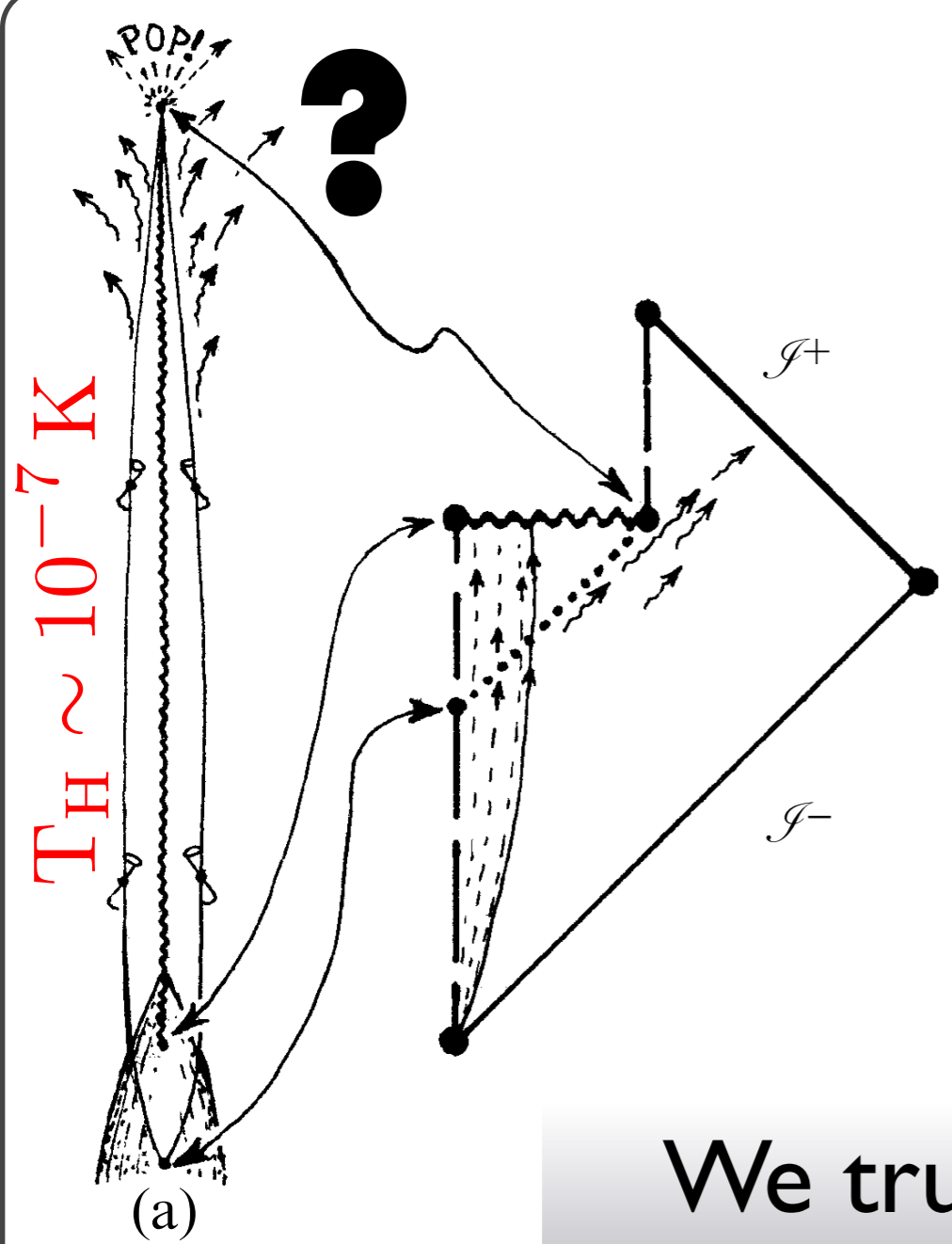

- (indirect) observations of the existence of black holes;
- **NO (indirect or direct) observation of the black hole evaporation process;**

WE THINK BUT WE DON'T KNOW THAT BLACK HOLES EVAPORATE!

We trust in quantum field theory, BUT:

- ☠ blue-shift of the modes at horizon
- ☠ robustness of HR to modification at UV



Introduction - The black hole evaporation process



[Images taken from 'The road to Reality', by Roger Penrose.]

$$T = \frac{g_H}{2\pi}$$

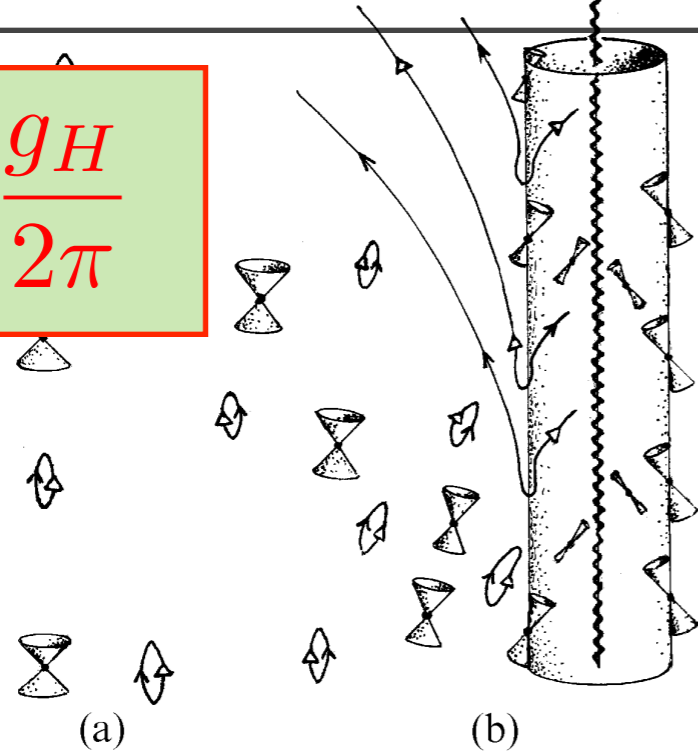

Pair-creation:

Separation of particle-anti-particle pairs from the quantum vacuum;
Negative norm modes absorbed by black hole;

[Particle Creation by Black Holes, by Stephen Hawking, in 1974]

$$|\beta_\omega|^2 = e^{-\frac{2\pi\omega}{g_H}} |\alpha_\omega|^2$$

$$\phi_\omega^{\text{in}} = \alpha_+^{\text{out}} + \beta_-^{\text{out}}$$

- Nature of Hawking process: Semi-classical quantum gravity effect, where the Einstein dynamics is not taken into consideration.
- Spontaneous versus stimulated emission: If the stimulated emission is there, the quantum will follow (Einstein).
- Black versus white hole emission: White holes are the time-reversal of black holes, and the Hawking process applies to both.



Analogies - Identity of relations/strong analogy



[Experimental black hole evaporation, by Bill Unruh; Vol 46, #21, PRL.]

Equation of motion for **linear** perturbations in analogue gravity systems:

$$\frac{1}{\sqrt{-g}} \partial_a (\sqrt{-g} g^{ab} \partial_b \phi_1) = 0$$

[General relativistic wave equation]

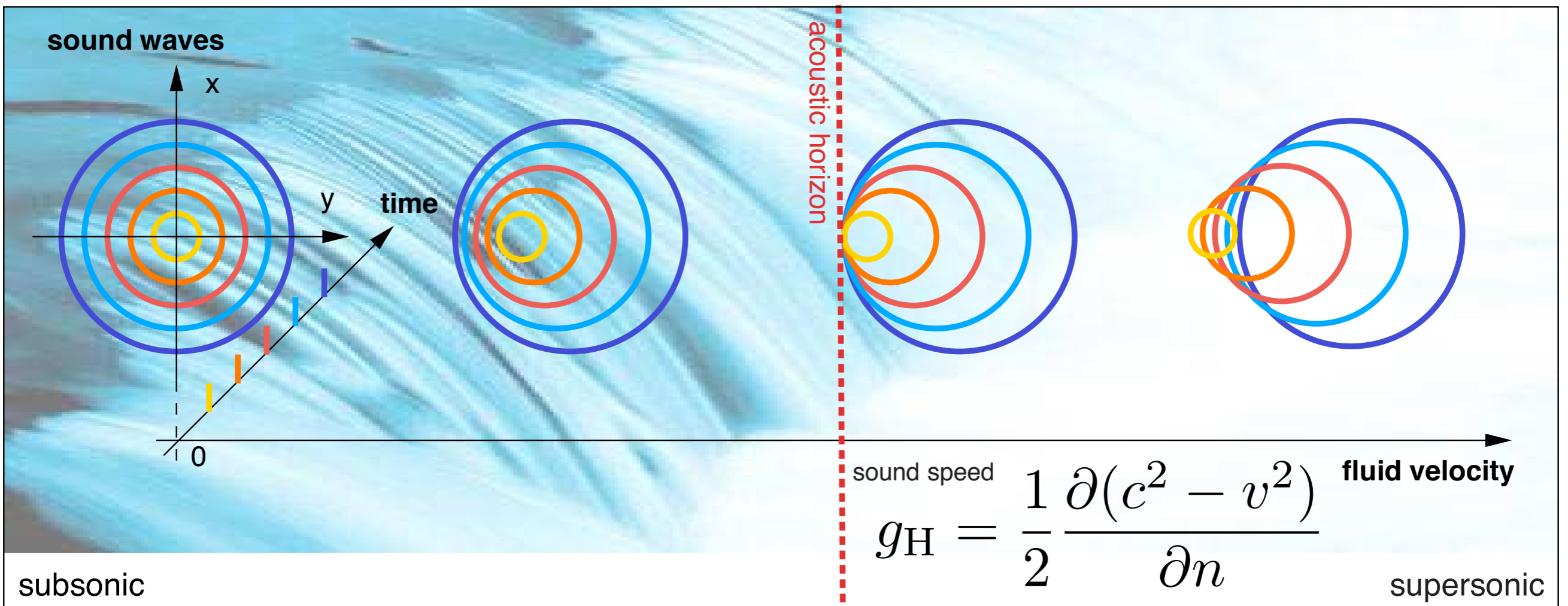

$$g_H = \frac{1}{2} \frac{\partial(c^2 - v^2)}{\partial n}$$

'Fully' determined by **effective** spacetime geometry:

$$g_{ab} = \left(\frac{\rho}{c} \right)^{2/(d-1)} \begin{bmatrix} -(c^2 - v^2) & -\vec{v}^T \\ -\vec{v} & \mathbf{I}_{d \times d} \end{bmatrix}$$



Our experiment in a nutshell

Set-up: Surface waves on open channel **flow** with varying depth.

- stationary
- irrotational
- incompressible
- inviscid

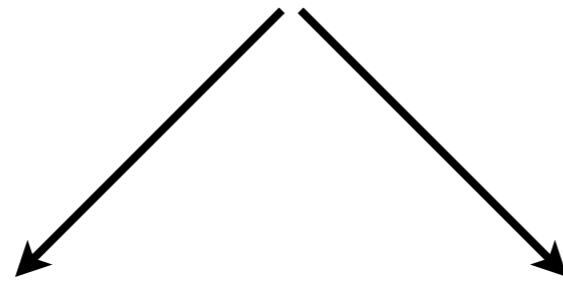

$$v = v(x) = \frac{q}{h(x)} \propto \frac{1}{h(x)} \quad c = c(x) \approx \sqrt{gh(x)} \propto \sqrt{h(x)}$$

Let's recall the acoustic line-element:

$$g_{ab} = \left(\frac{\rho}{c}\right)^{2/(d-1)} \begin{bmatrix} -(c^2 - v^2) & -\vec{v}^T \\ -\vec{v} & \mathbf{I}_{d \times d} \end{bmatrix}$$

Goal: Set up black and white horizon & detect stimulated conversion to pos. & neg. waves who's relative amplitudes obey HS.

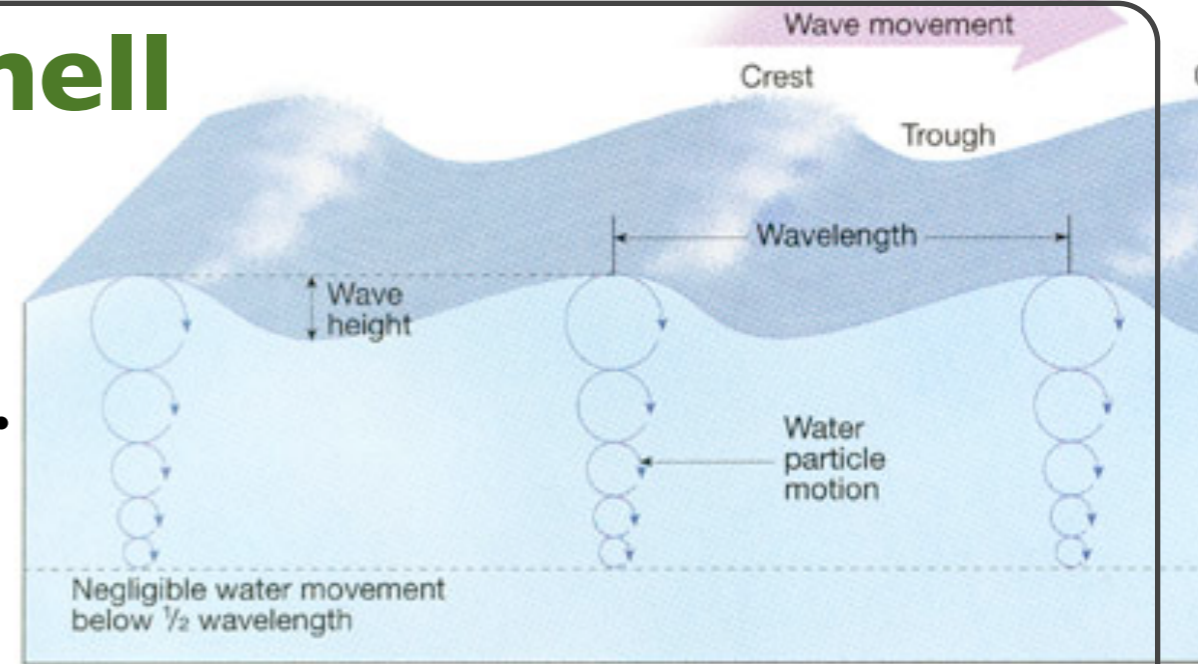

Figure 14.2 This diagram illustrates the basic parts of a wave as well as the movement of water particles. Negligible water movement occurs below a depth equal to one-half the wavelength.



Experimental apparatus

6



Our flume tank (7.47m long and 15.4cm wide):

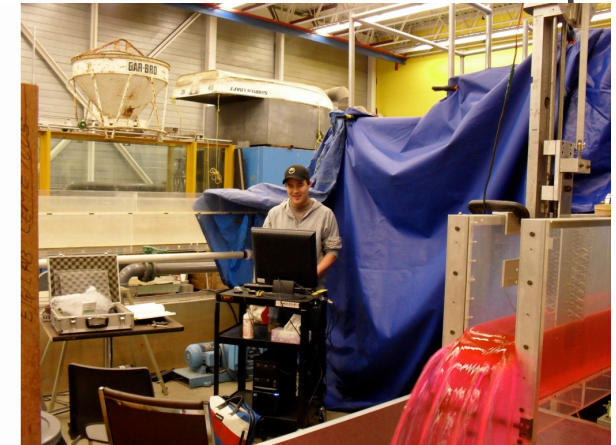
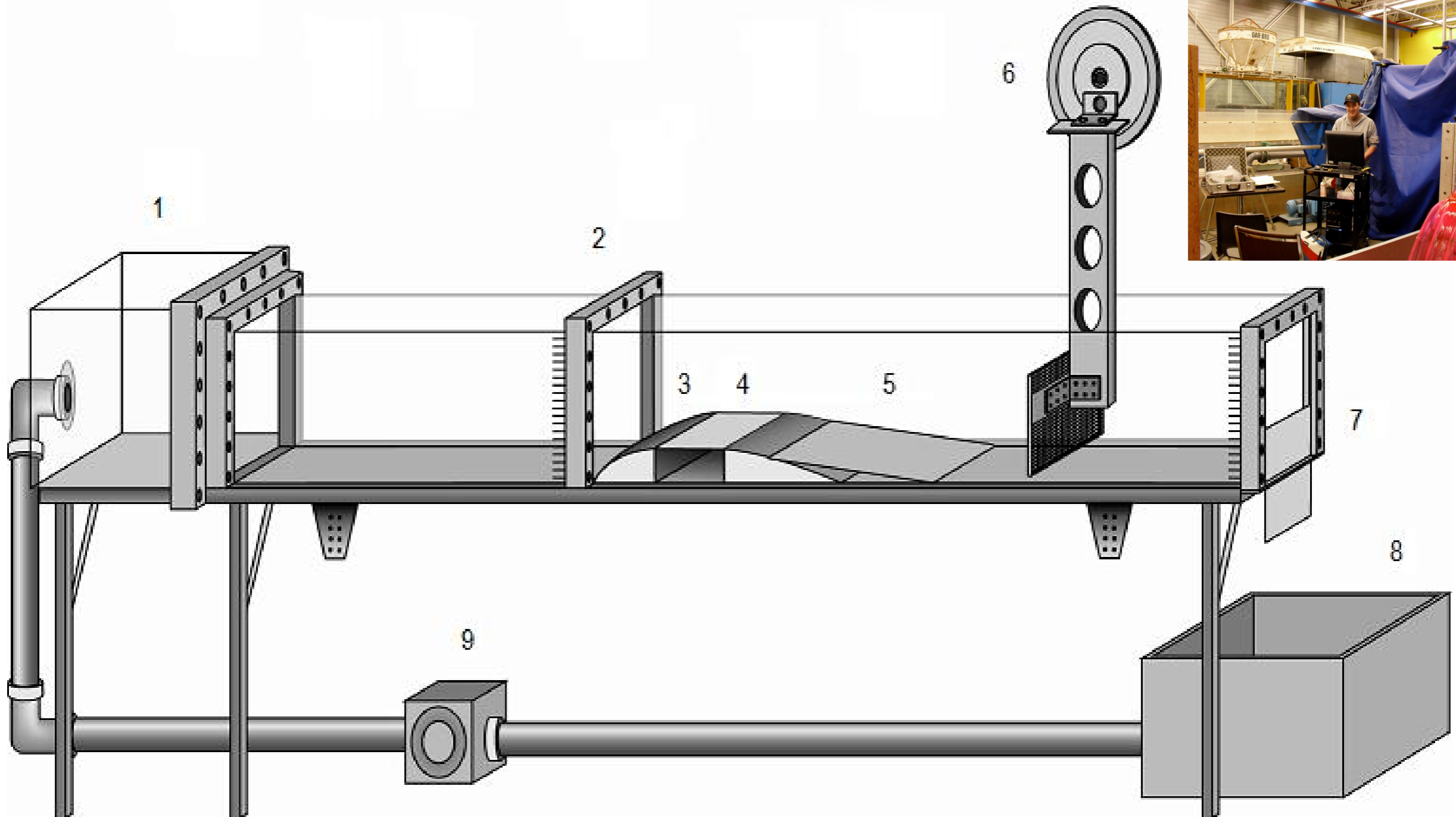



Physics of surface waves

$$\Omega^2 = \left(gk + \frac{\sigma}{\rho} k^3 \right) \tanh(k_2 h)$$

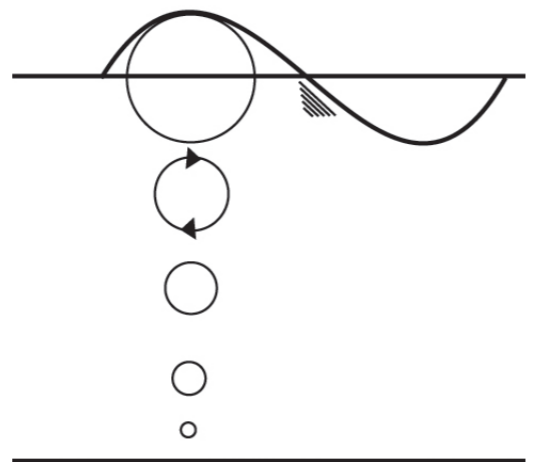
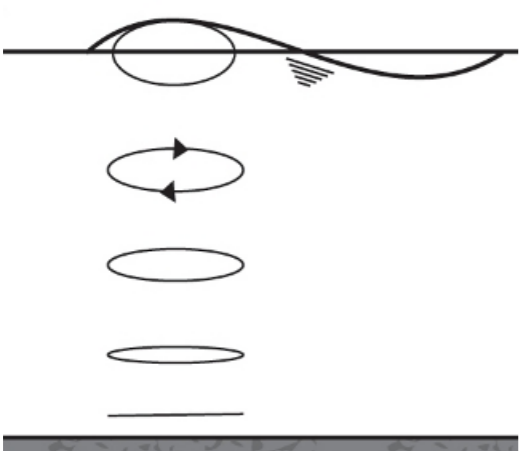
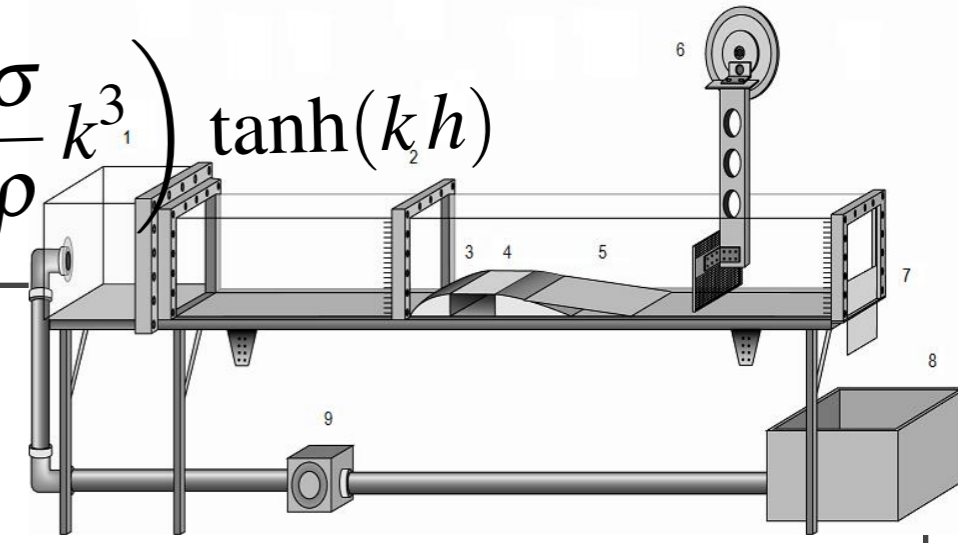

shallow:

$$\Omega = \sqrt{gh} k$$

deep:

$$\Omega = \sqrt{gk}$$

$$\omega_0 = \pm \Omega_x(\pm k), \text{ where } v_0 = 0$$

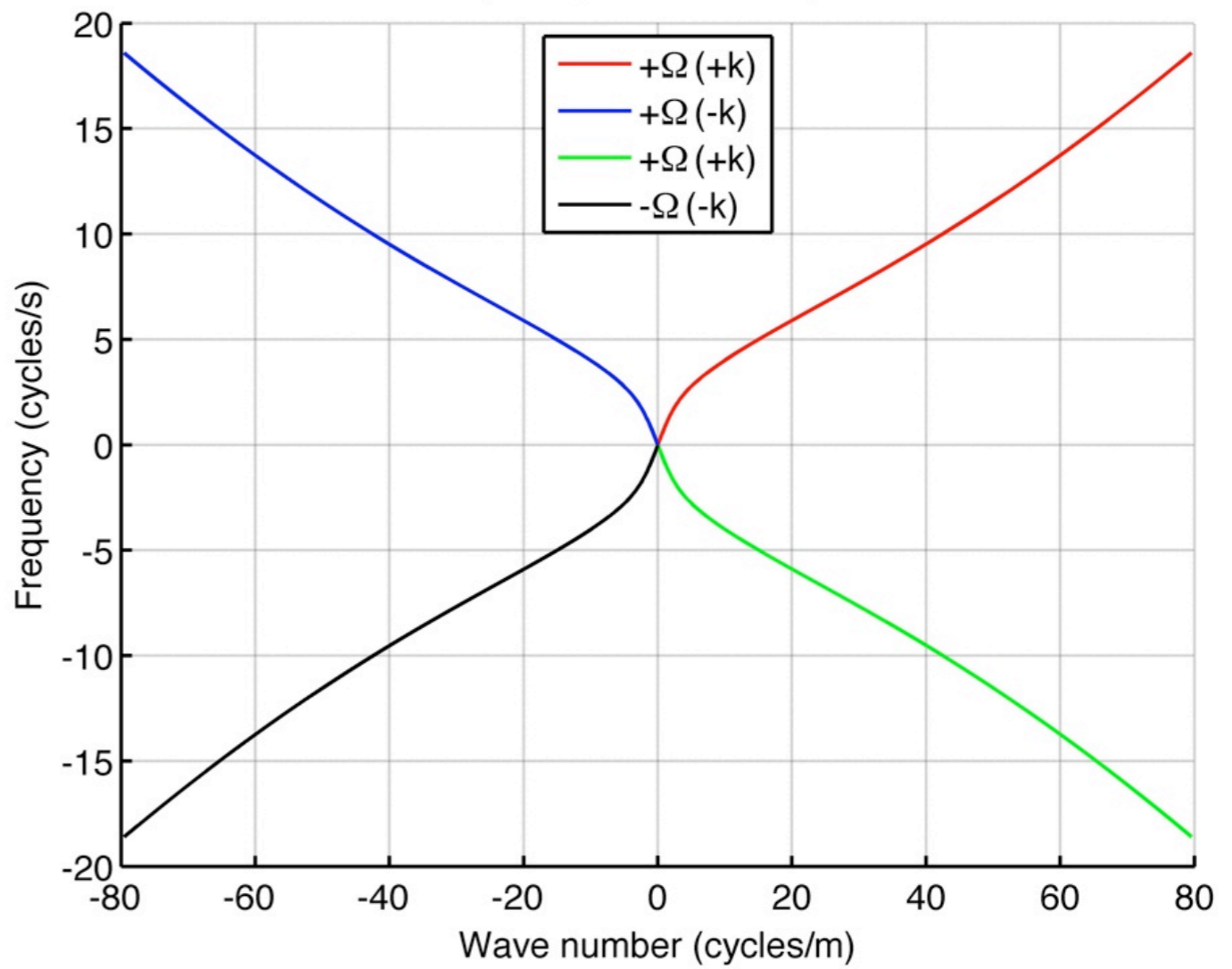



Physics of surface waves

$$\Omega^2 = \left(gk + \frac{\sigma}{\rho} k^3 \right) \tanh(k_2 h)$$

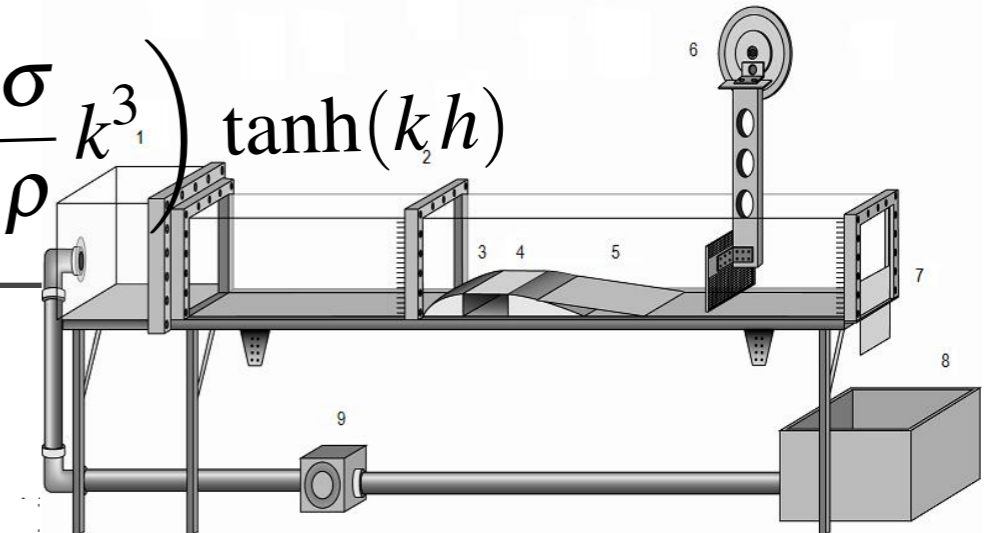

$$\Omega_{\text{LAB}} = \Omega_{\text{WATER}} \pm v k$$

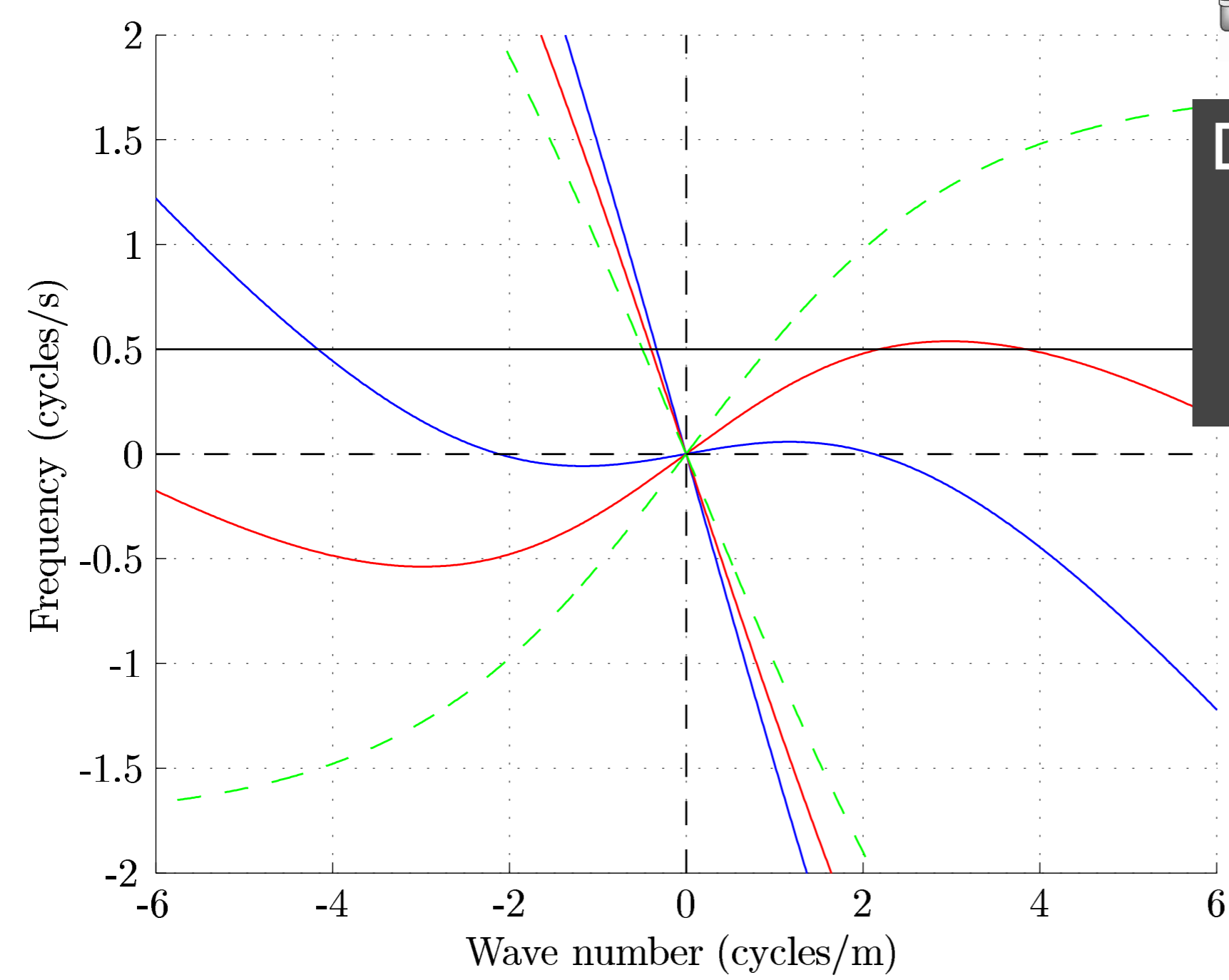

Dispersion relation for
 maximum height
 conversion point
 minimum height

shallow: $\Omega = \sqrt{gh} k$

deep: $\Omega = \sqrt{gk}$

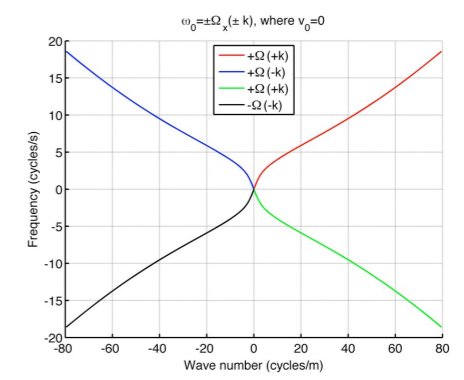



1st experimental result: Flume without the obstacle



9

Background

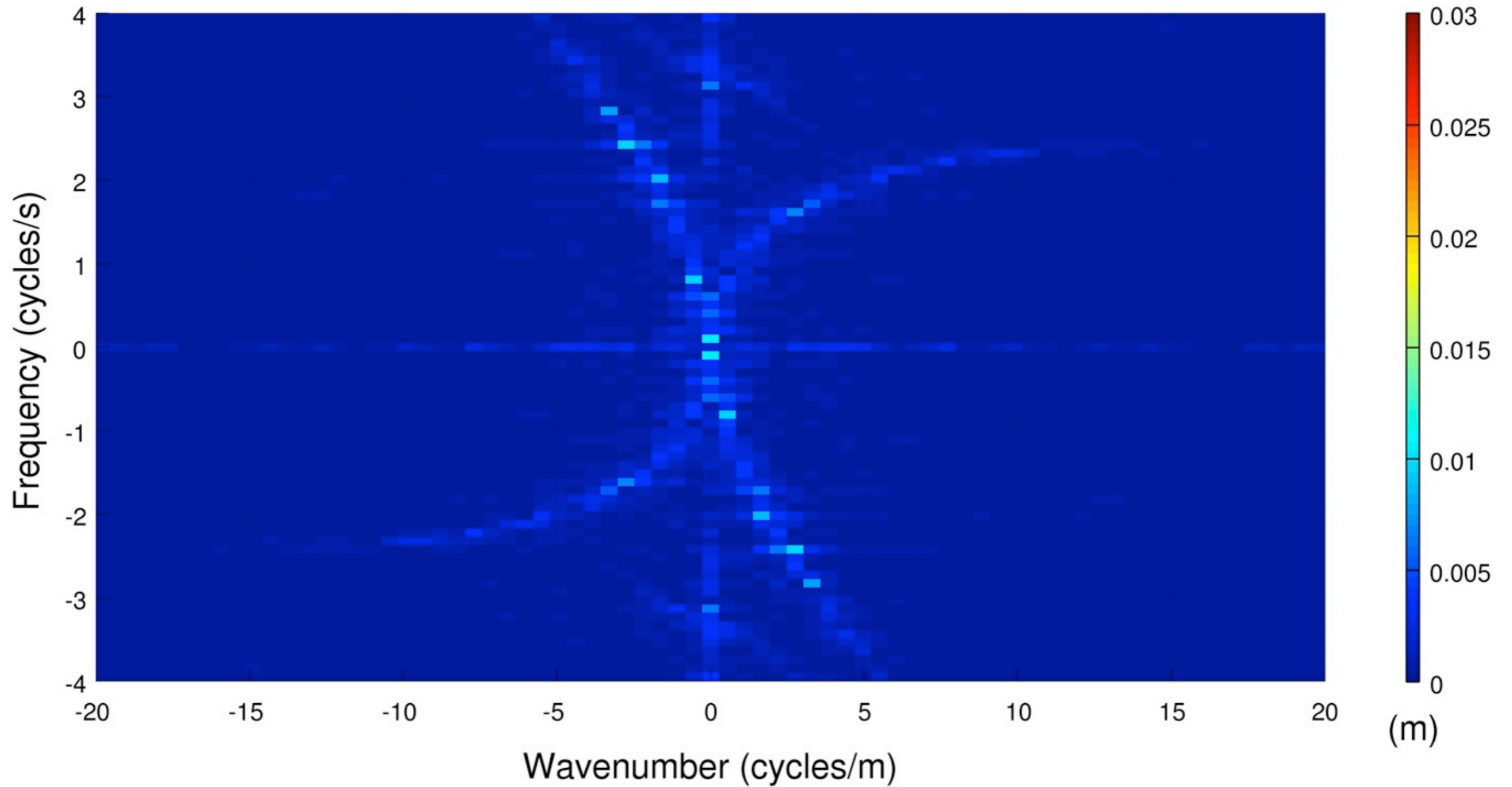

Application: Indirect way to measure the flow rate...



1st experimental result: Flume without the obstacle



9

Background

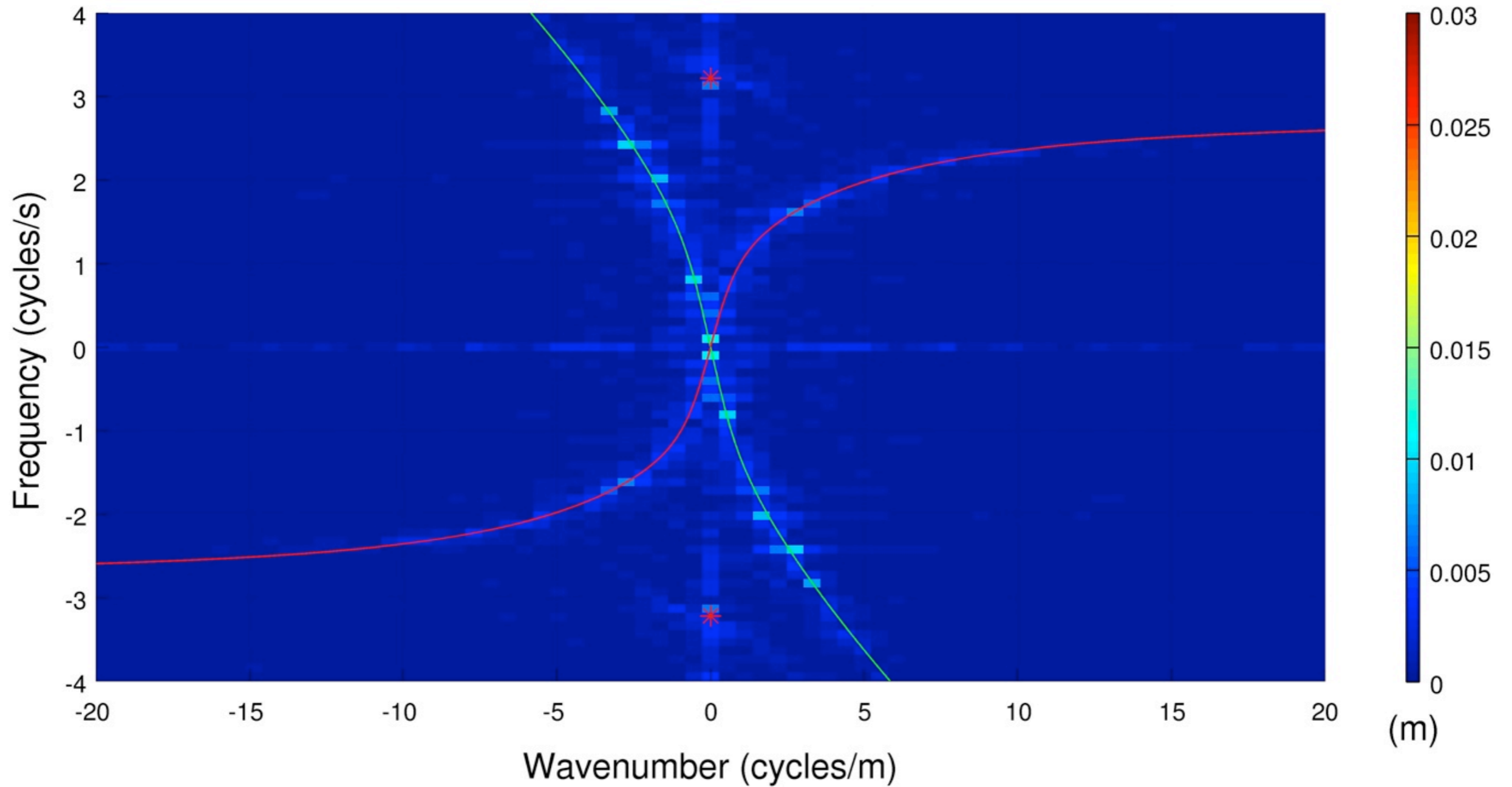

Application: Indirect way to measure the flow rate...



Free surface: our observable

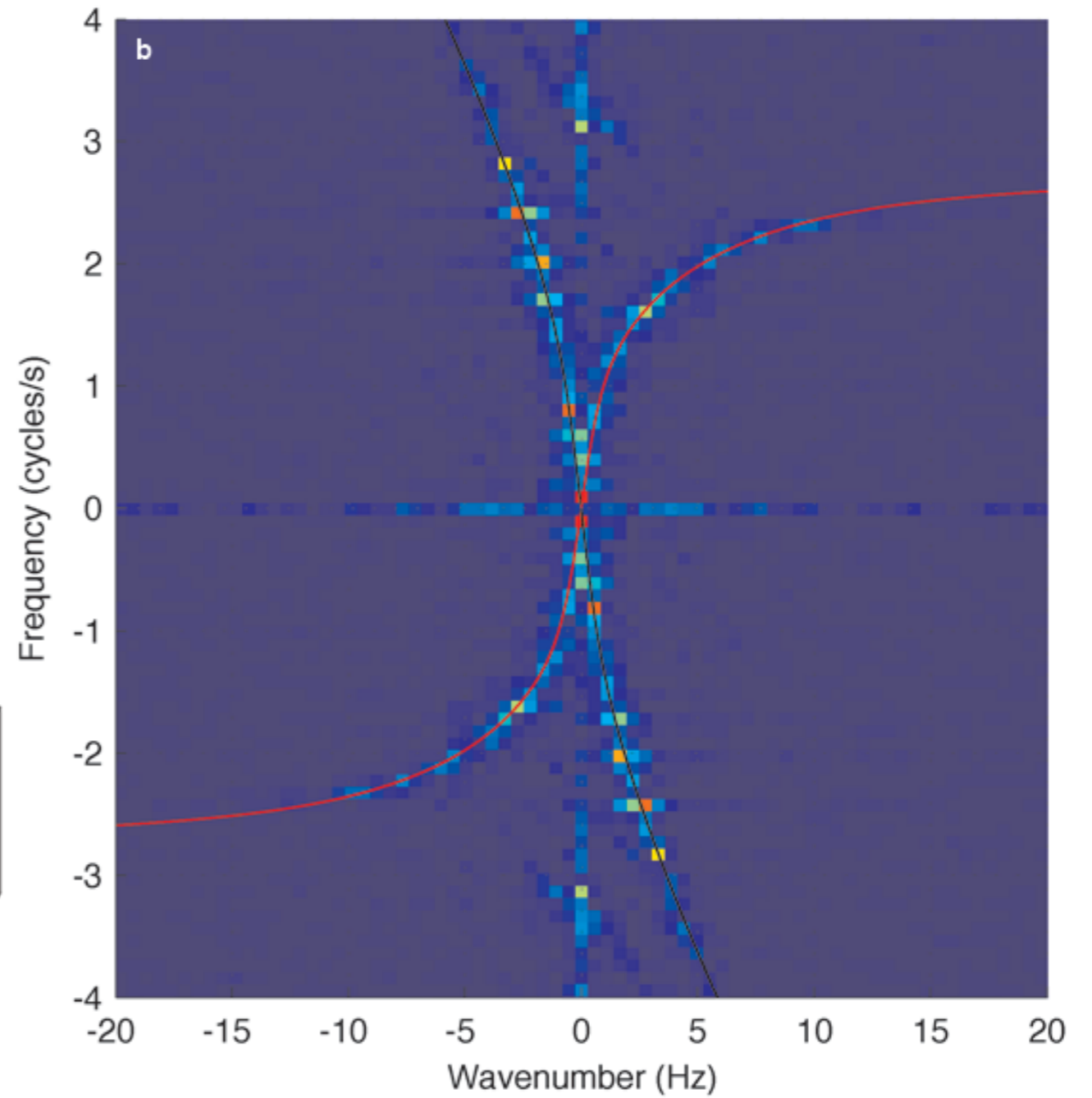
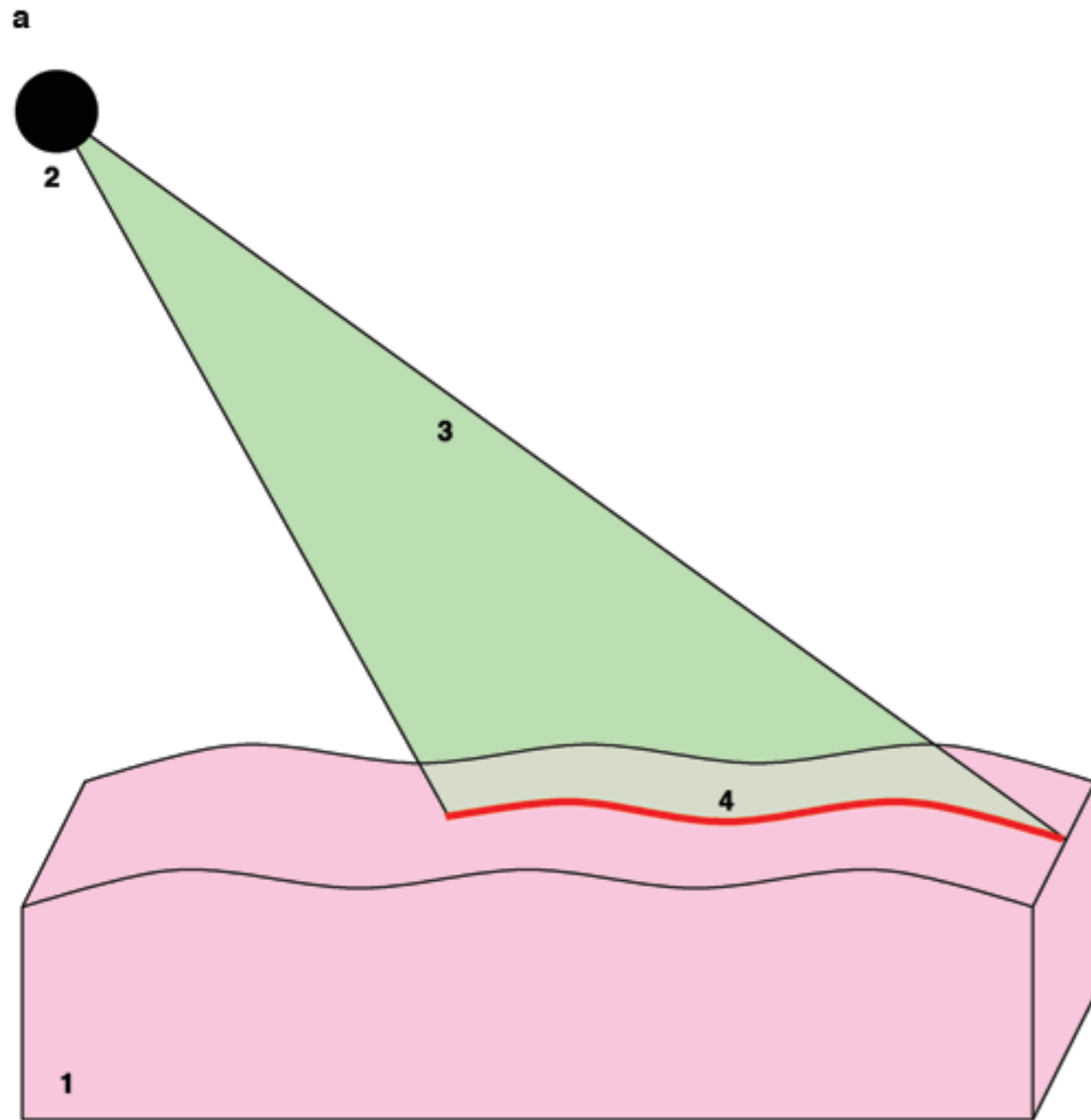
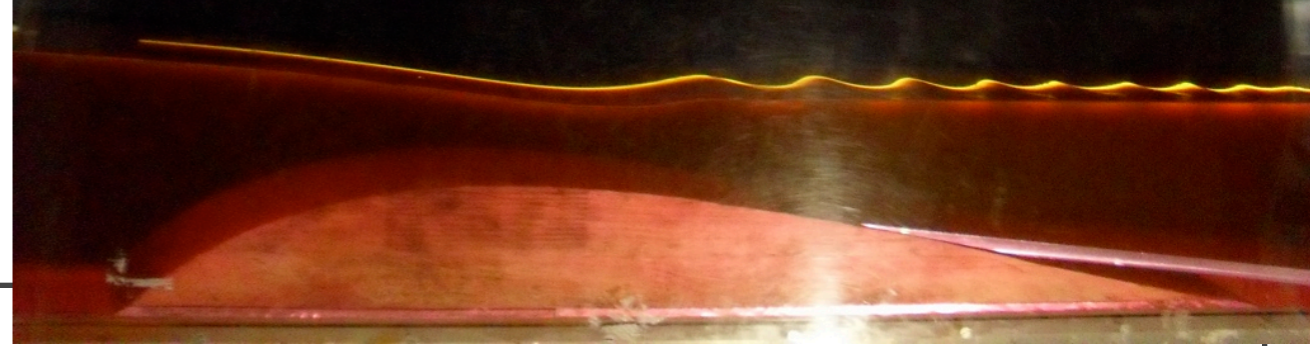



Free surface: our observable

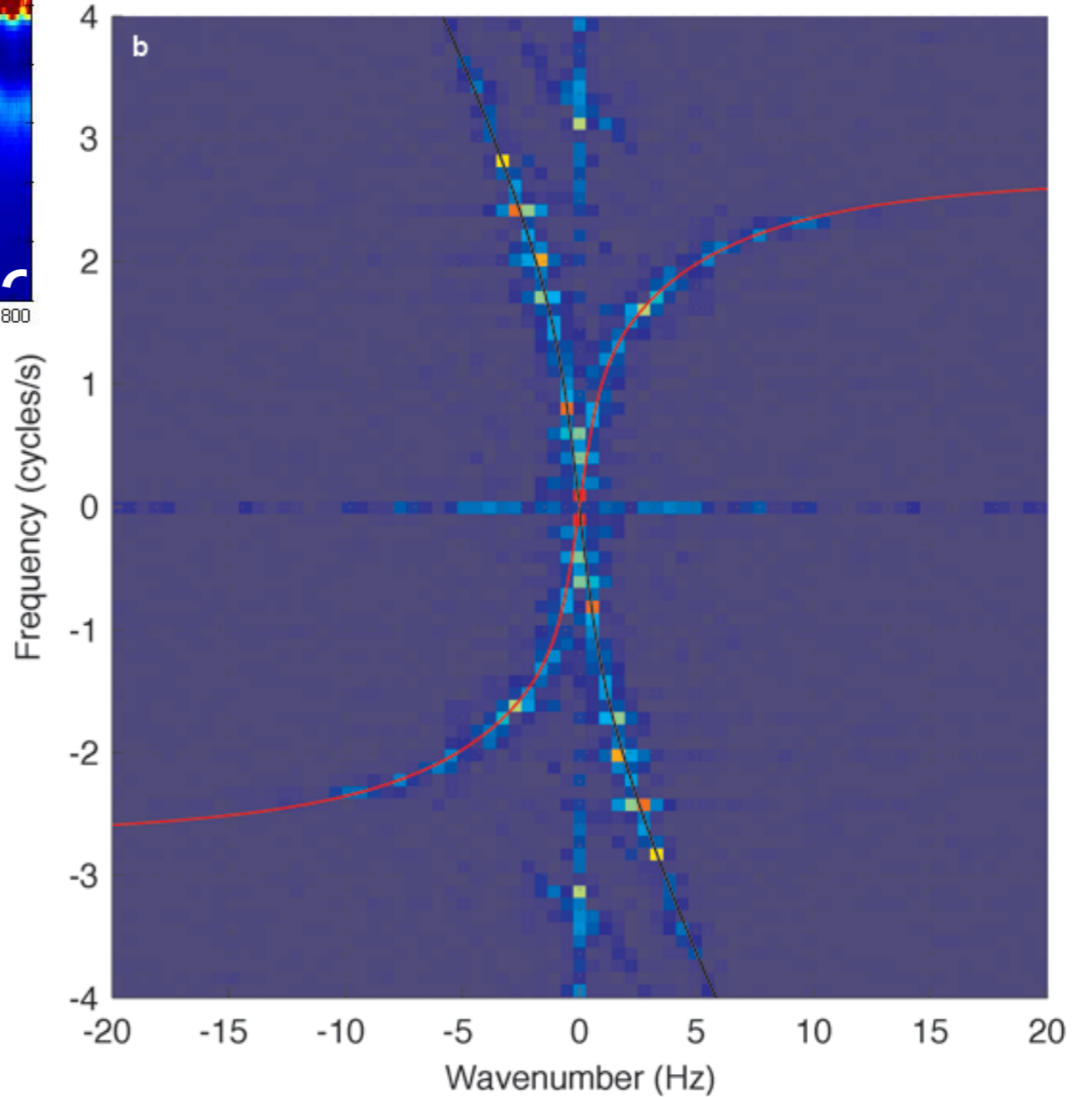
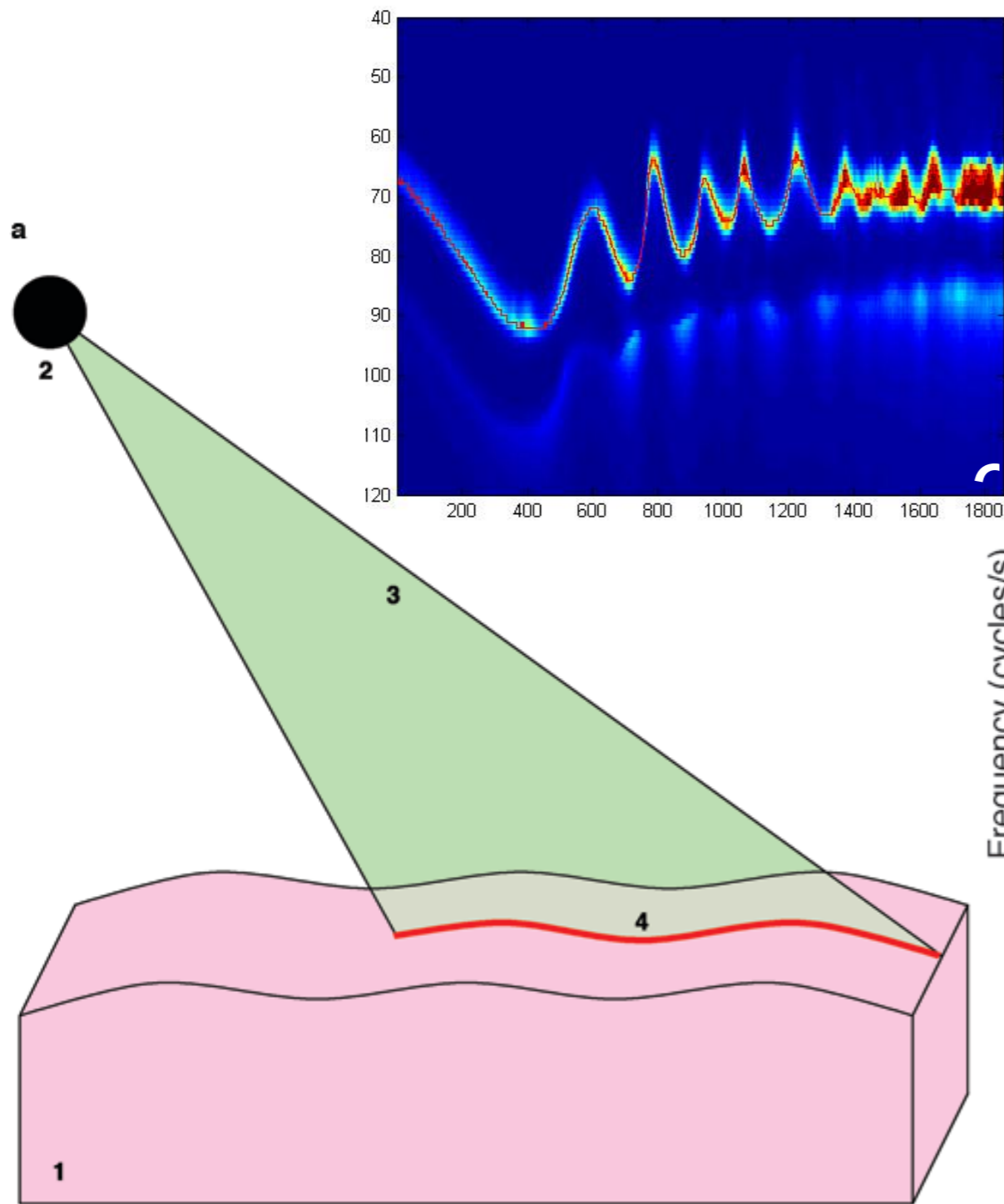
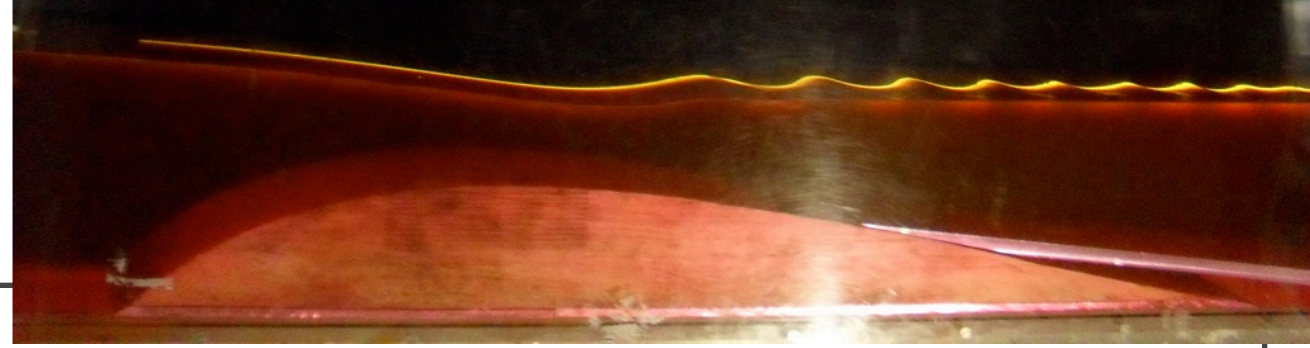



Free surface: our observable

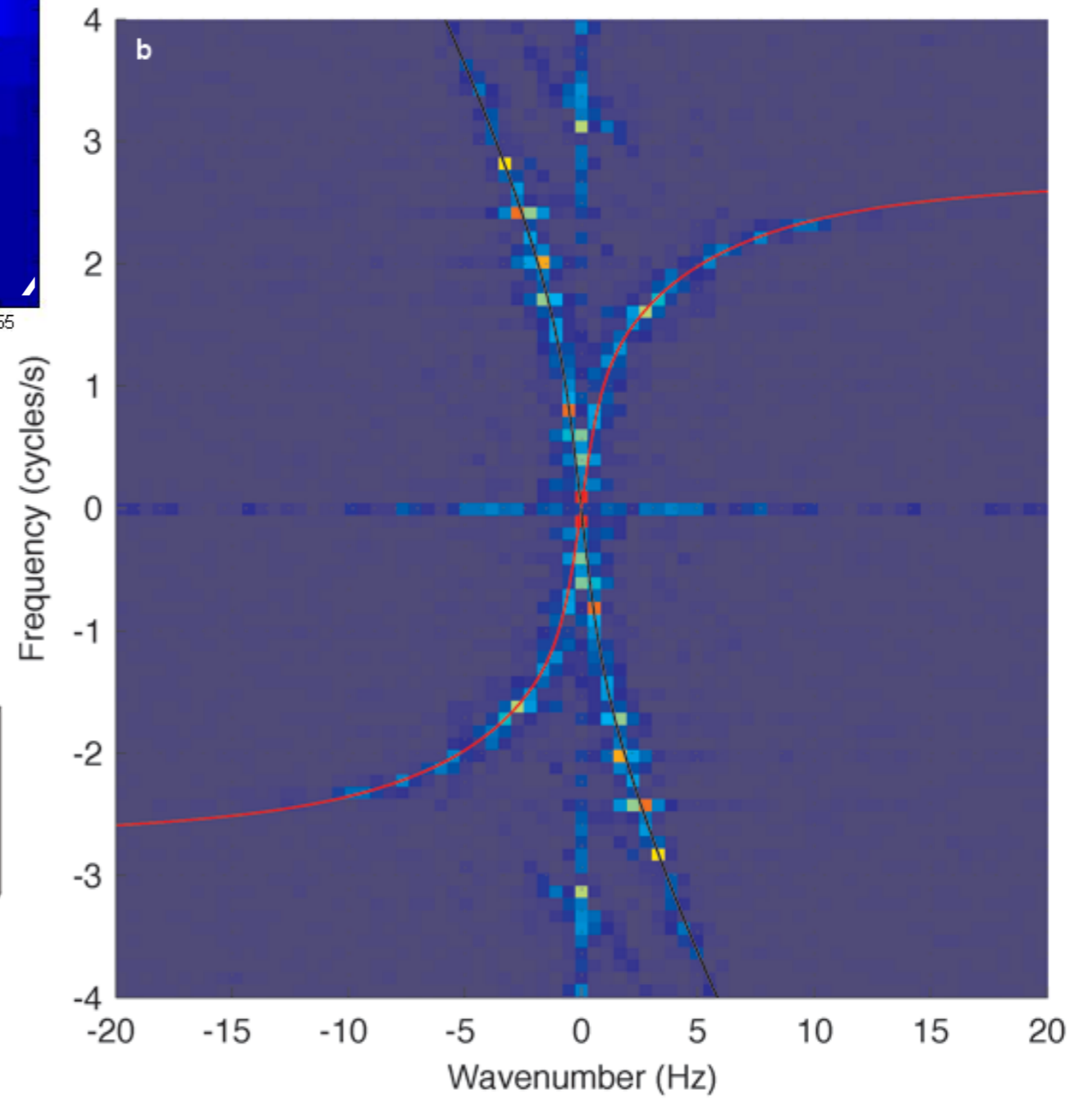
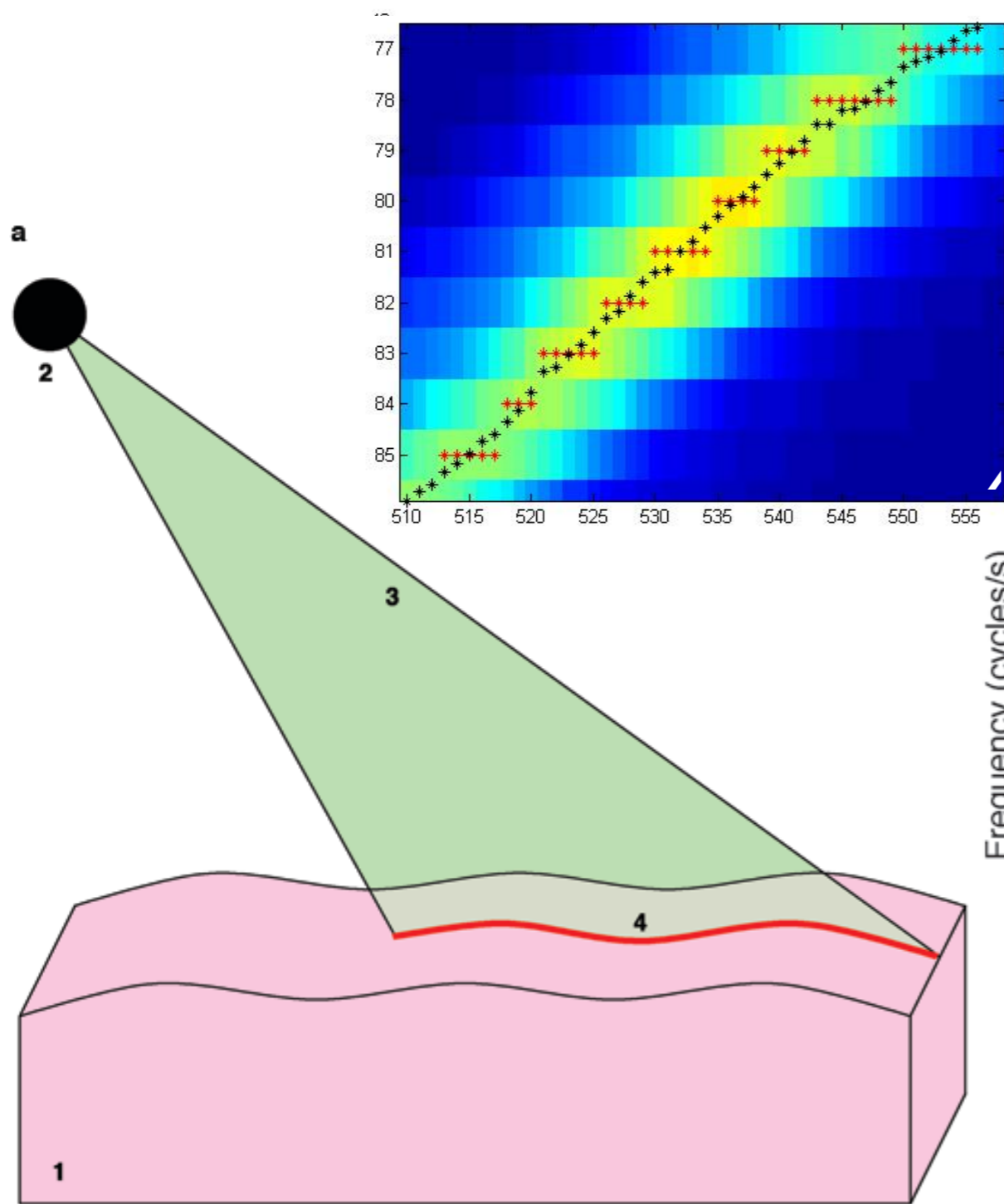
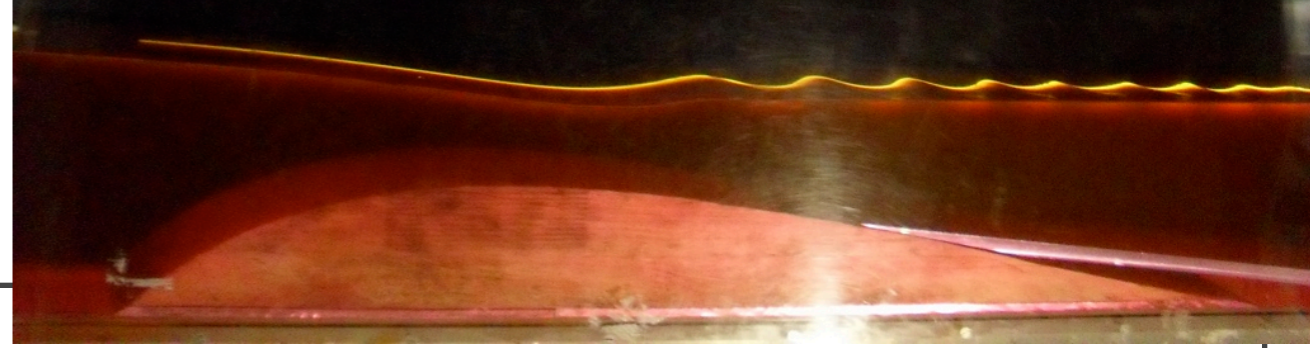



Stimulated system - generated ingoing waves



11

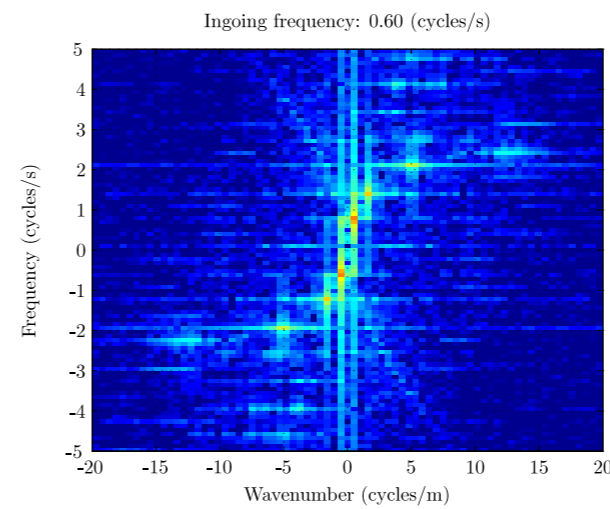
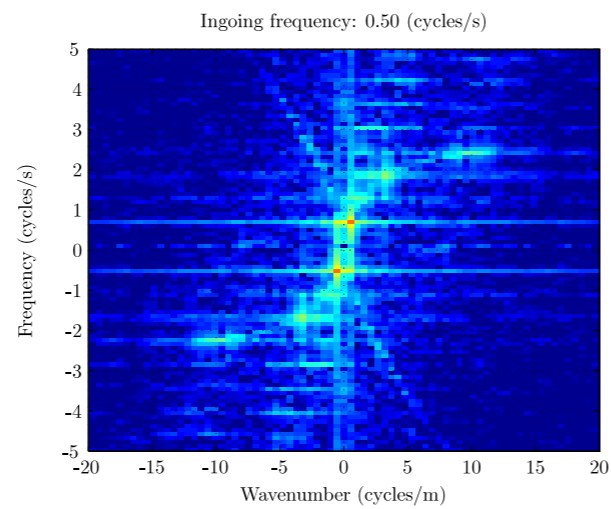
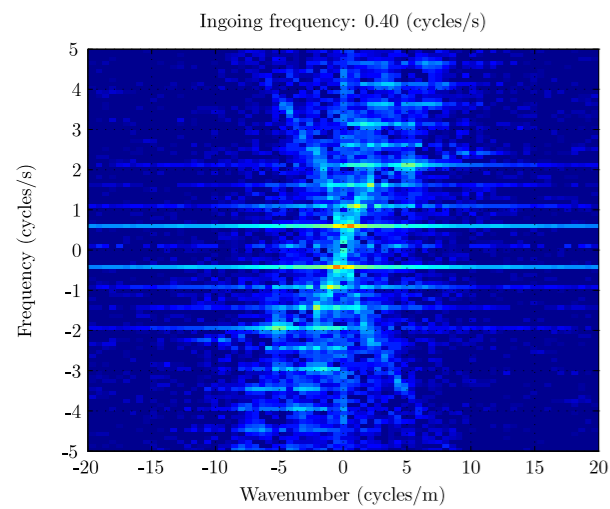
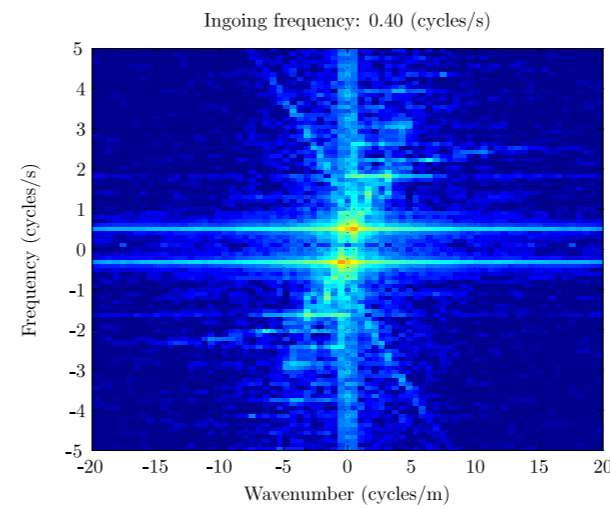
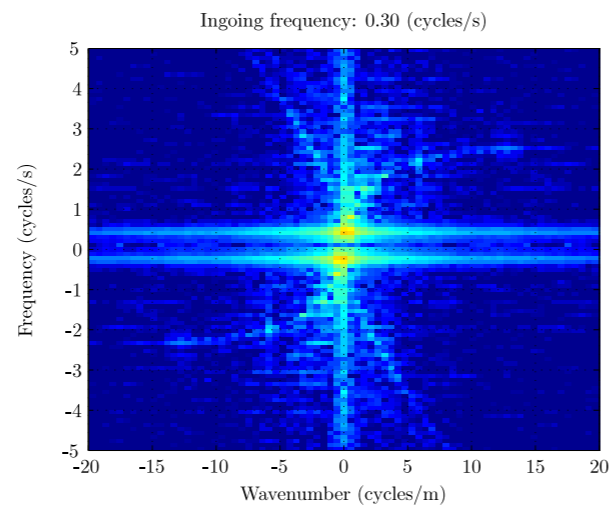
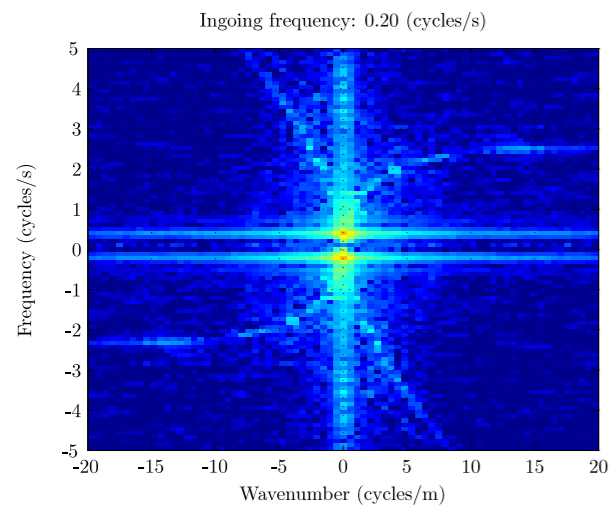
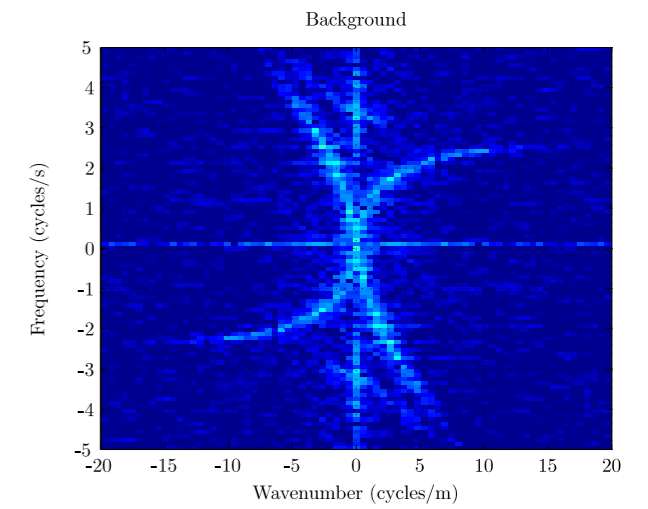
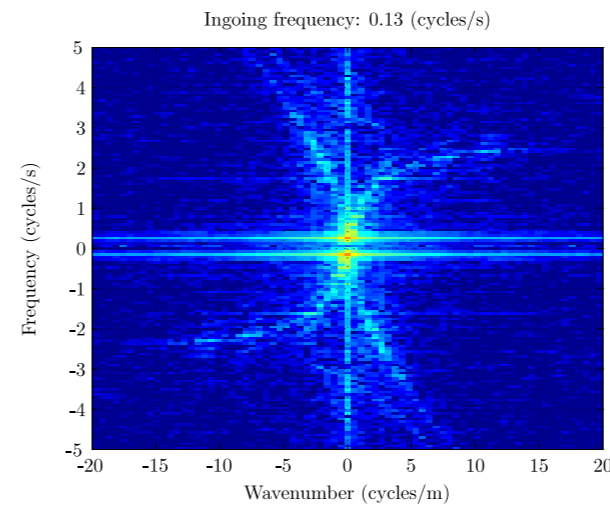
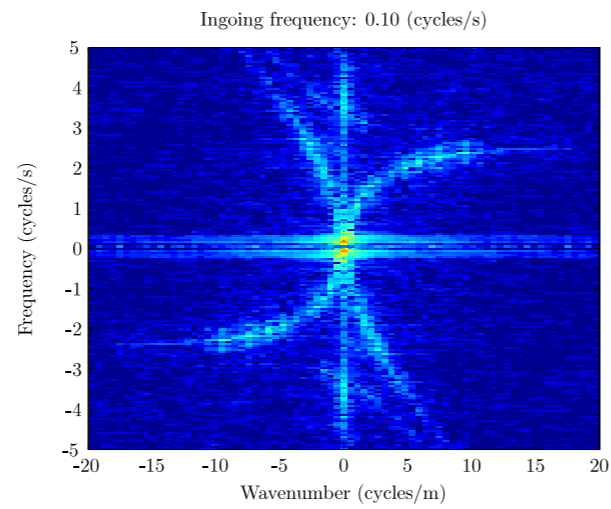
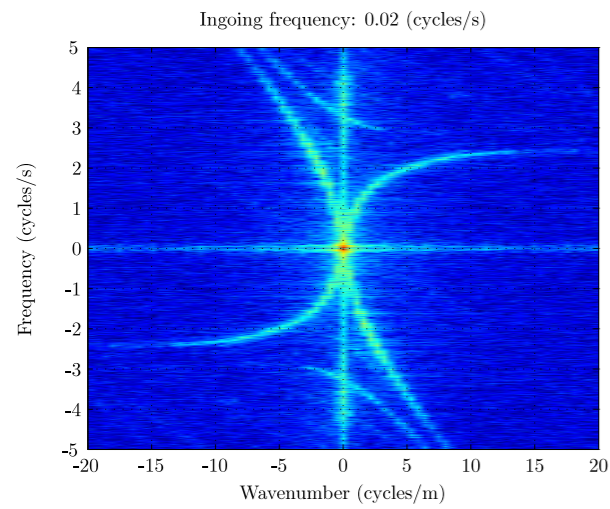



Right and left moving waves: Pair-creation process

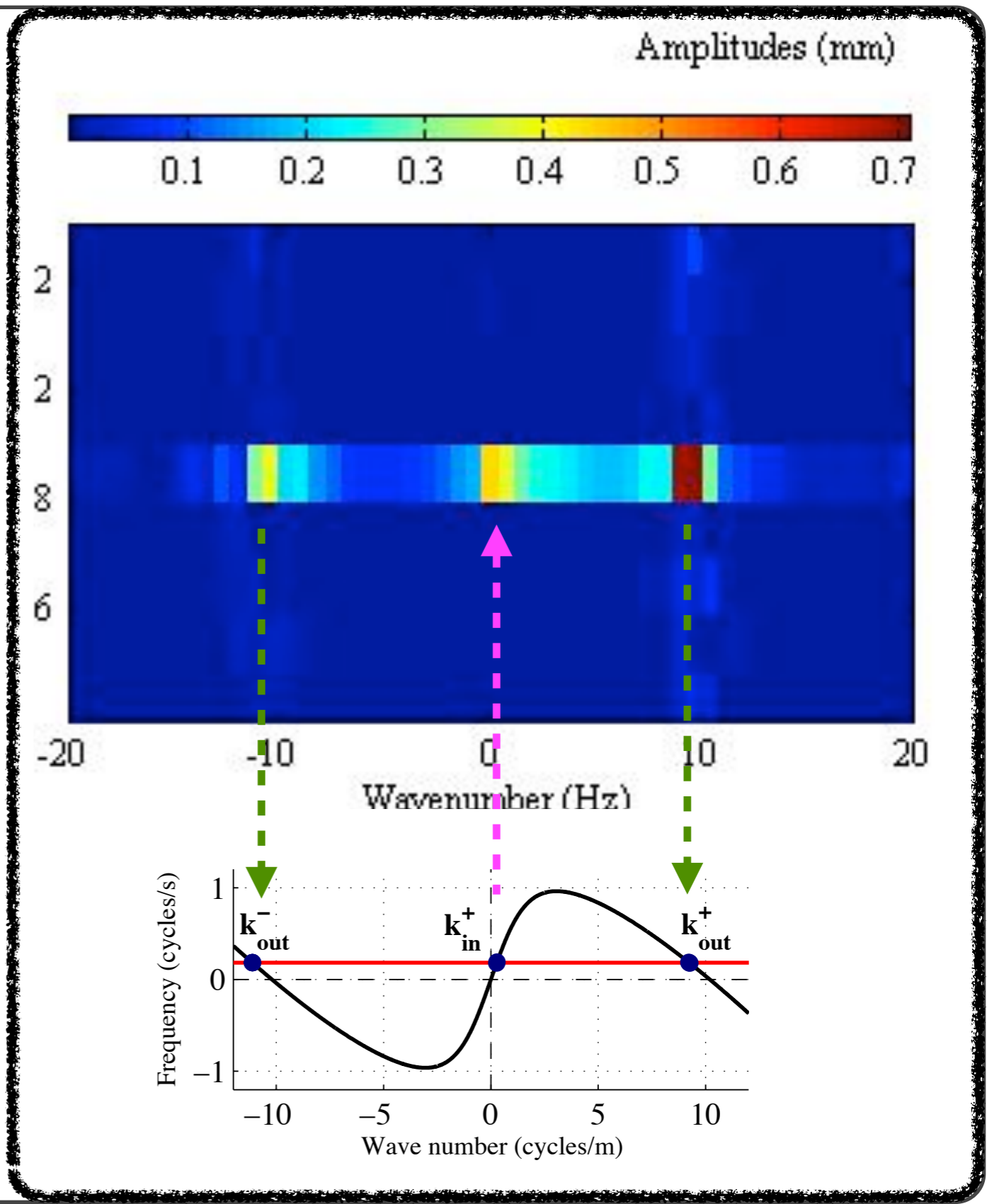
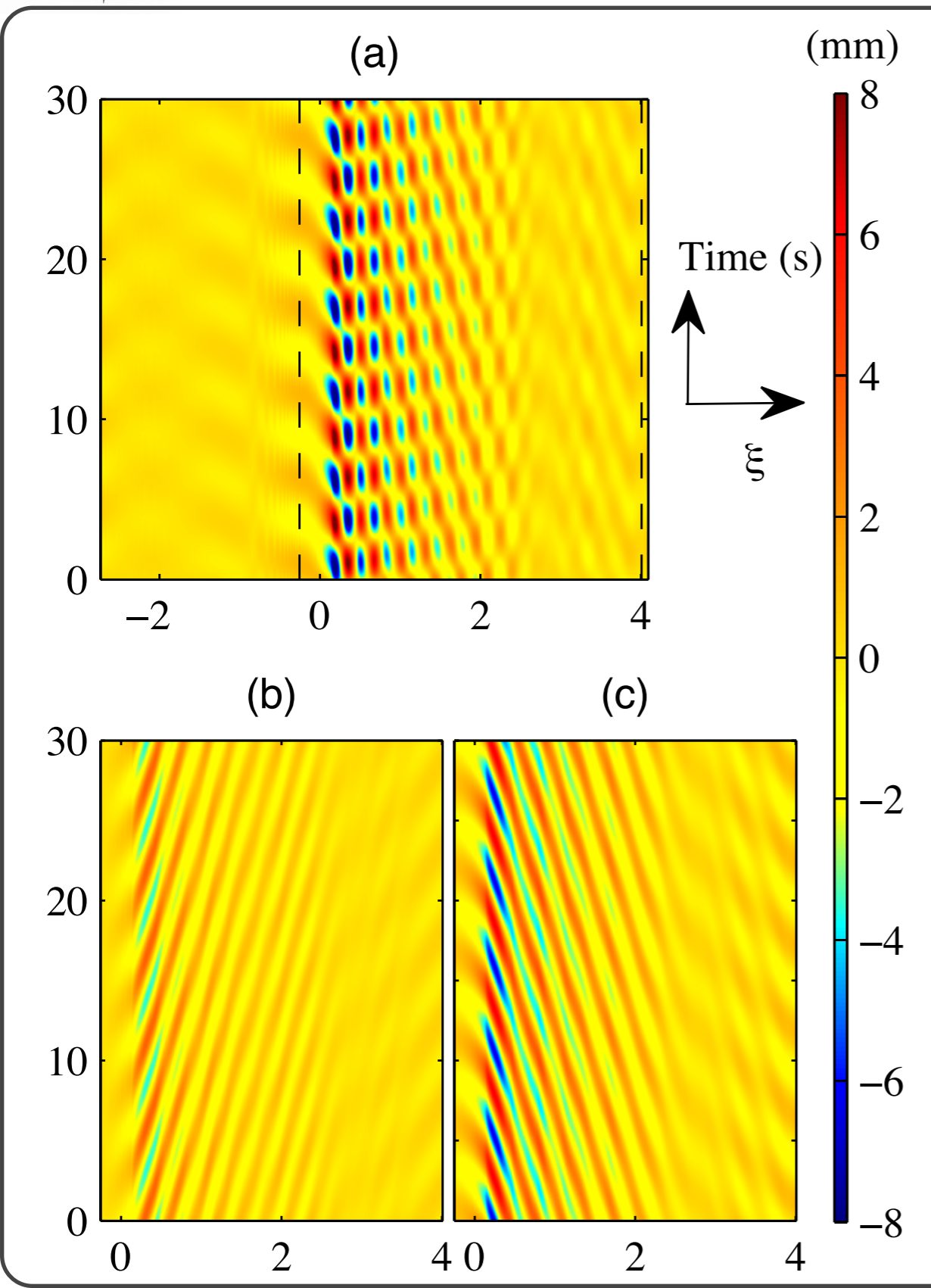



(i) Amplitudes of converted waves depending on ingoing frequency:

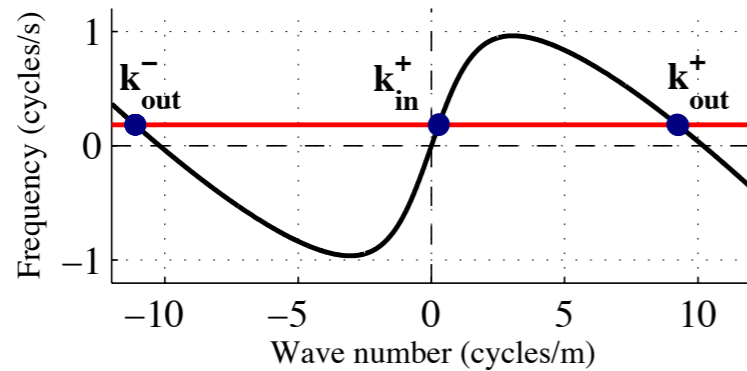

(ii) what is a wave (particle) nearby the white hole horizon..?

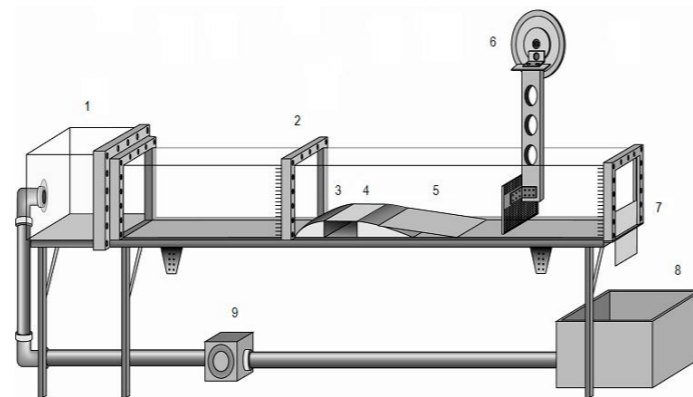
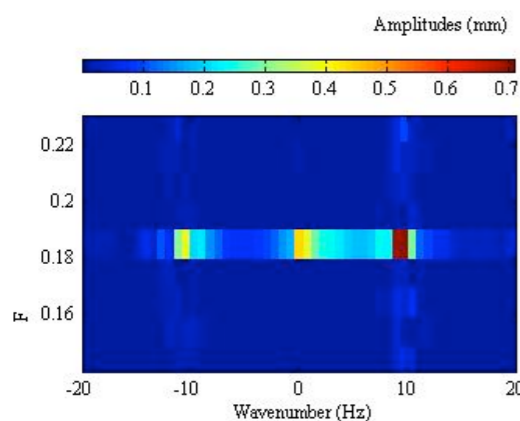

(ii) Norm is conserved: $\int \frac{|A(f, \kappa)|^2}{f + \kappa} d\kappa$



(i) Amplitudes of converted waves depending on ingoing frequency:

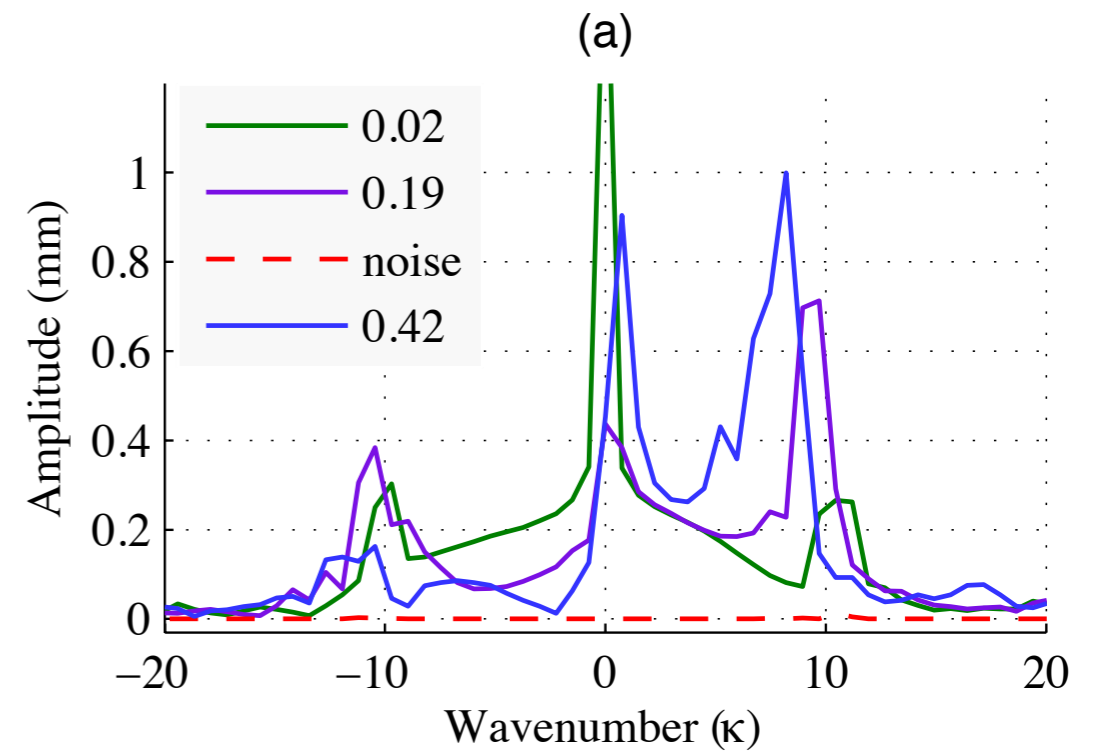
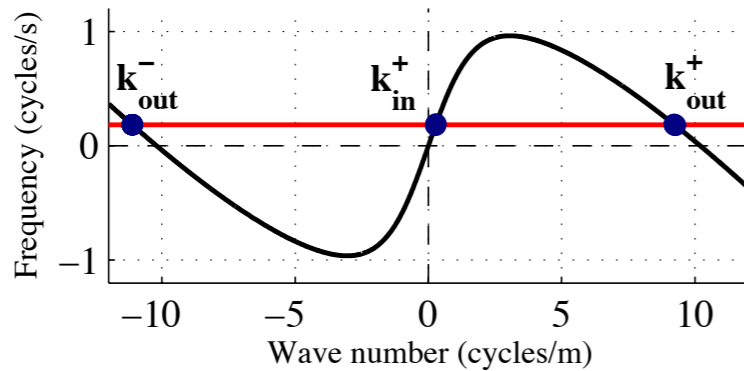

(ii) what is a wave (particle) nearby the white hole horizon..?

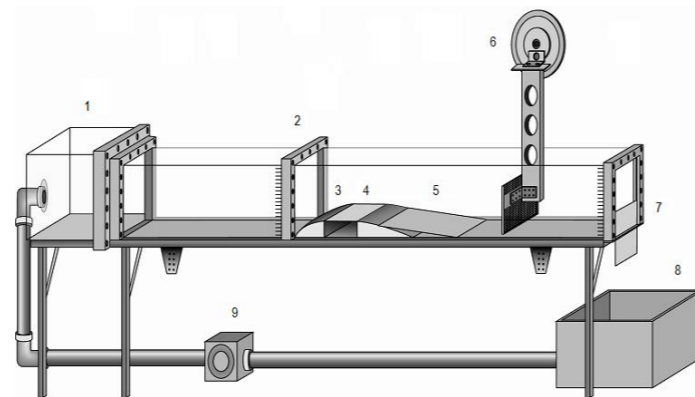
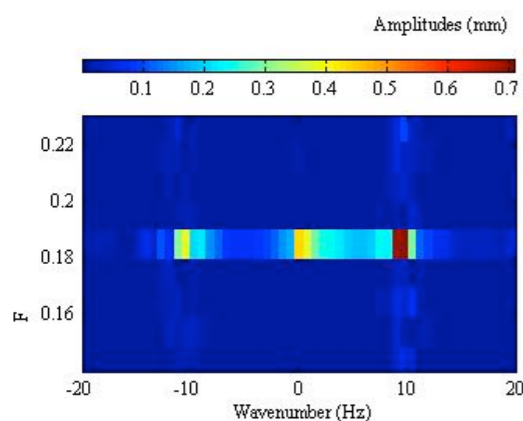

(ii) Norm is conserved: $\int \frac{|A(f, \kappa)|^2}{f + \kappa} d\kappa$



(i) Amplitudes of converted waves depending on ingoing frequency:

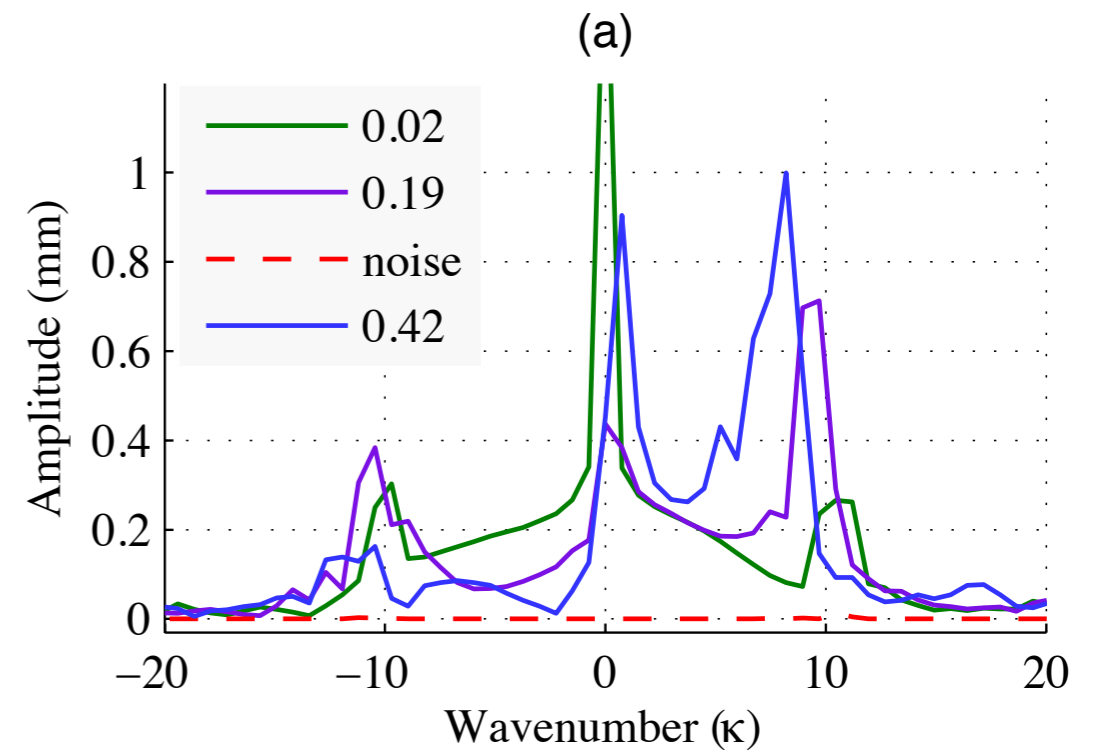
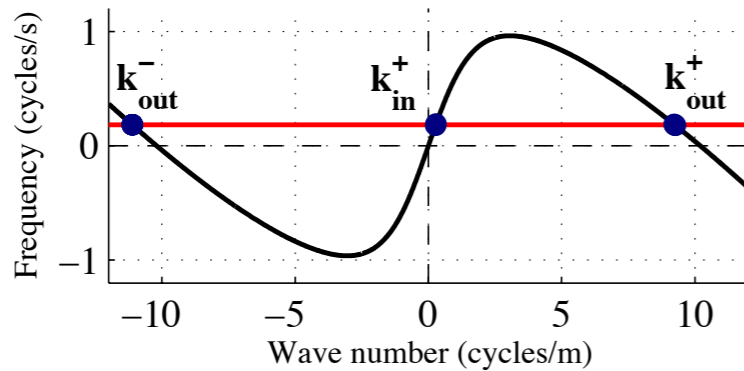

(ii) what is a wave (particle) nearby the white hole horizon..?

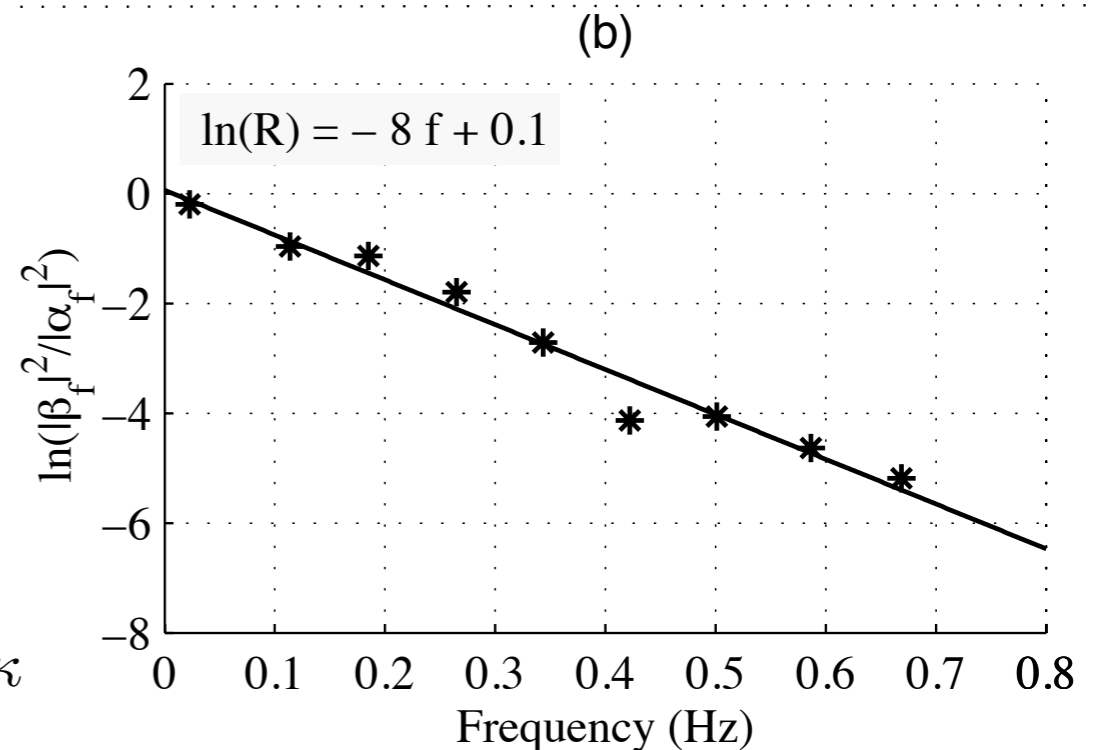
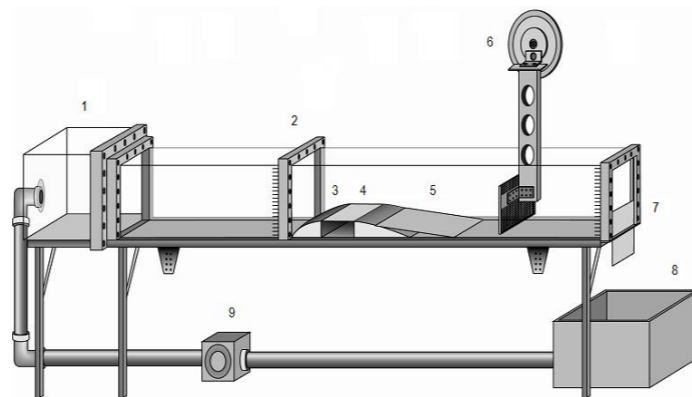
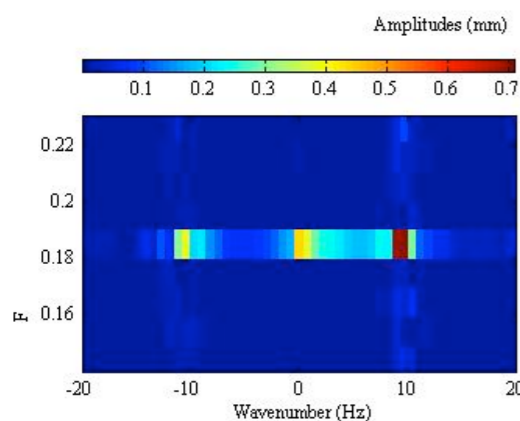

(ii) Norm is conserved: $\int \frac{|A(f, \kappa)|^2}{f + \kappa} d\kappa$

– **Preliminary work**, however a first check confirmed that $|\beta_\omega|^2 = e^{-\frac{2\pi\omega}{g_H}} |\alpha_\omega|^2$

Order of magnitude is right at the place where the waves get blocked!

$$g_H = \frac{1}{2} \frac{\partial(c^2 - v^2)}{\partial n}$$

✓ **Stimulated Hawking process [pair-creation with a thermal spectra] is confirmed at white hole in analogue gravity system.**

– **The thermal emission is a universal phenomenon, surviving fluid-dynamic deviations (viscosity, vorticity) and vastly altered dispersion relations.**

Spontaneous emission straightforward, but undetectable; superfluid experiments necessary...